

Hover Camera Passport **User Manual**

V 2.1 2017.05

Table of Contents

Introduction	4
In-Box Contents	4
Diagram of Hover Camera Passport	5
Before you Begin	6
Charging the Battery	6
Installing & Removing the Battery	6
Installing the Battery	6
Removing the battery	7
Downloading the Hover Camera App	7
Pre-Flight Check	7
Environment Requirements for Flight	8
Basic Operation	9
Status lights	9
Powering On/Off	10
Powering On	10
Powering Off	10
Standby Mode	10
Pairing Hover Camera Passport to Your Mobile Device	10
Release and Hover	13
Retrieving Hover Camera Passport from Flight	14
Low Battery Level	15
Introduction to Functions	15
Owner Mode	16
Manual Control	17
Group Photo & Bird's Eye	19
Running & Cycling	20
Orbit	21
360 Spin	21
Tilt and Yaw	22
Adjusting Exposure	23
Setting Automatic Exposure	23
Setting Automatic Exposure Lock	23
Social Hub	23
Album	23
Transferring Files from Hover Camera Passport to Your Computer	24
Editing and Sharing	25
Video editing and sharing	25
Video clip	25
Video synthesis	26

Music Adding.....	26
Saving and sharing.....	26
Settings	27
General.....	27
About	27
Firmware Update.....	27
Memory Management.....	28
Settings	28
Control Mode	28
Auto Filter.....	28
Owner Mode.....	29
Record Video.....	29
Watermark:	30
Set WiFi Info	30
Factory Reset	31
Support	31
Help Center	31
Send Feedback	31
Tutorial.....	31
Social Networking	32
Maintenance & Care.....	32
Replacing the Bottom Carbon Fiber Plate	32
Replacing Propellers	33
Battery Disposal	34
Storage & Transportation	34
Updating Hover Camera Passport Firmware	35
Appendix	37
Specifications	37
Hover Camera Passport	37
Camera	37
Battery.....	37
Charger.....	37
After-Sales Information.....	38
Compliance Information	38
FCC Compliance Statement.....	38
FCC Radiation Exposure Statement.....	38
IC RSS Warning	39
IC Radiation Exposure Statement	39
Canadian IC Warning	39
EU Compliance Statement	40
RoHS Compliance Statement.....	40
WEEE Compliance Statement.....	40

Introduction

Hover Camera Passport is the world's leading AI-embedded flying camera drone, which features safety, portability, and ease of use. Hover Camera Passport weighs only 242g and is able to take 13MP photos and record 4K video. Hover Camera Passport is capable of diverse functions, such as Auto-Follow, Face Recognition, Gesture Recognition, Orbit and One-tap Landing. Users can easily operate Hover Camera Passport from their mobile device with the Hover Camera app.

In-Box Contents

In-Box Contents	Quantity
Hover Camera Passport	1
Product Protective Case*	1
Rechargeable Li-Po Battery Pack	2
Easy-Carry Bag	1
Propeller (CW × 2, CCW × 2) *	4
Screw Driver Kit (Includes: 2 screw drivers; 12 screws: M1.2×6, M1.4×6) *	1
USB Cable*	1
Charger	1
Adapter	1
Quick Guide	1
Warranty Policy*	1
Battery Safety Instructions	1
Disclaimer and Safety Instructions	1
In-Box Item List	1

Note: The contents marked with “*” only exist in deluxe edition.

Diagram of Hover Camera Passport

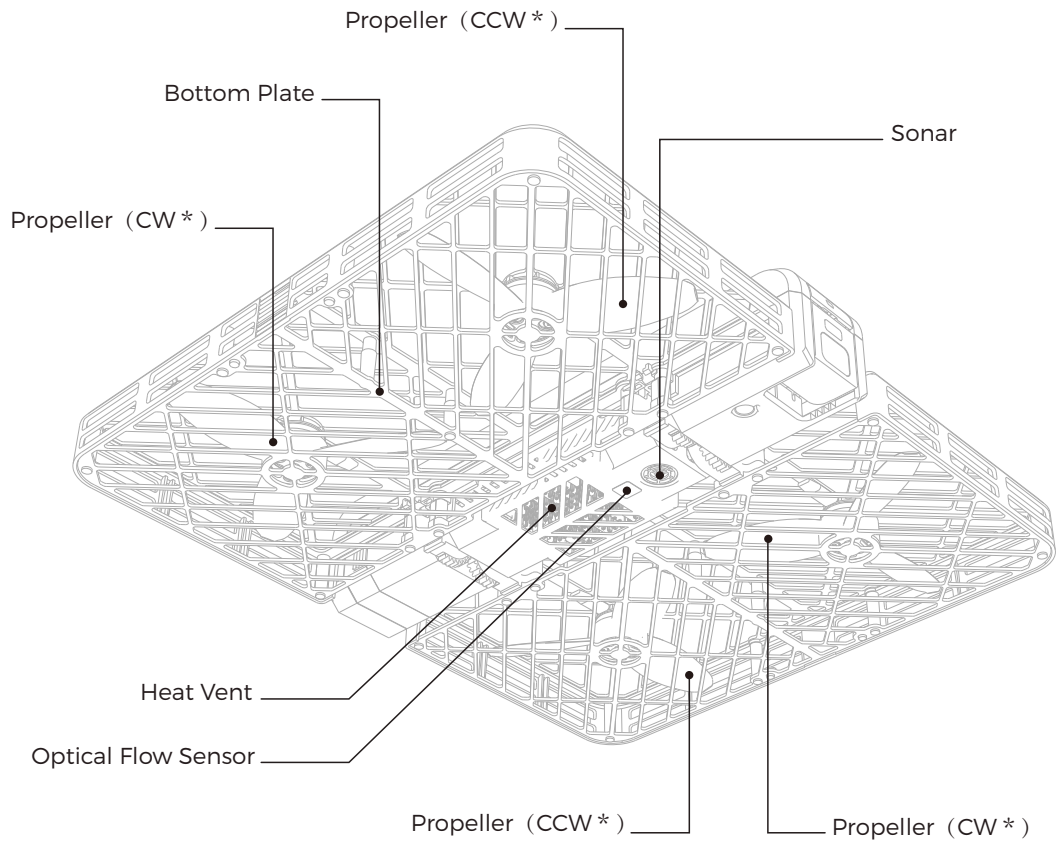
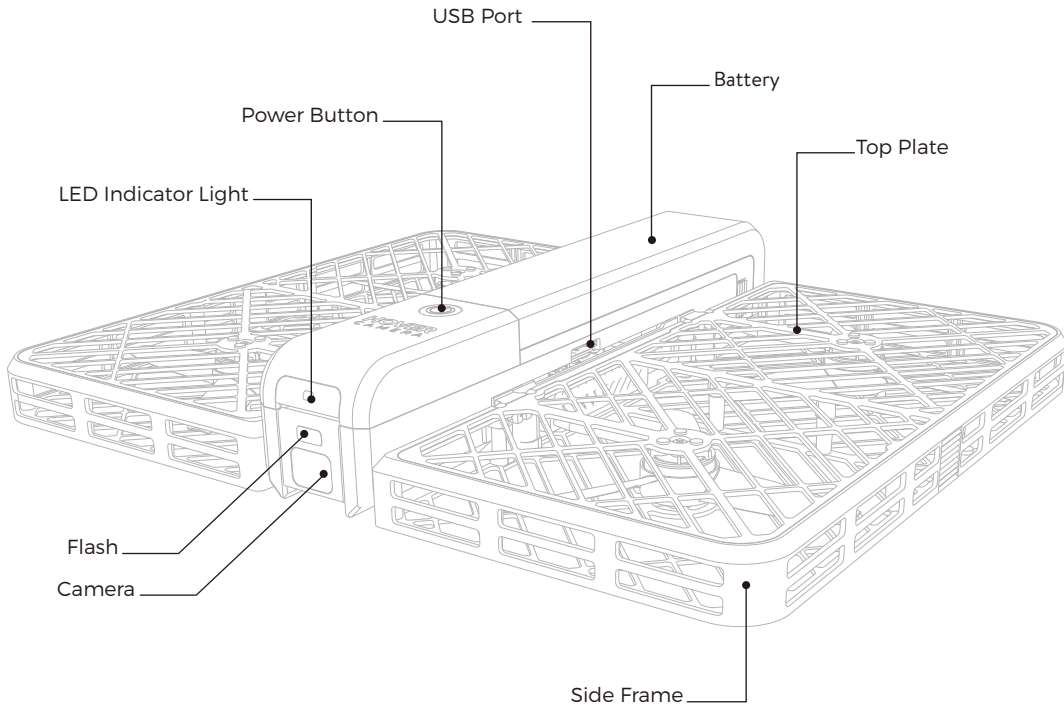

* CW: Clockwise

* CCW: Counter-Clockwise

Before you Begin

Charging the Battery

To charge the batteries, plug them into the charger as shown in the following diagram:

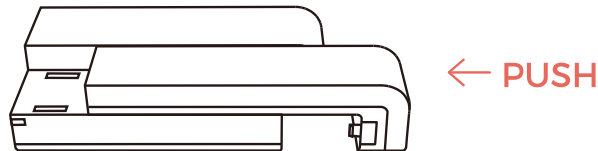

The LED indicator light indicates the charge status as follows:



Solid Yellow: **Charging**

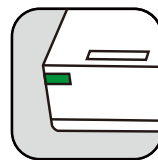

Solid Green: **Fully Charged**

Note:

-
- When a Li-Po battery is left discharged for an extended period, the battery will over-discharge and deactivate. To reactivate the battery, charge it using the Hover Camera Passport battery charger. The LED indicator light on the charger will turn solid yellow during reactivation. If reactivation fails or if the battery fails to charge, the LED indicator light will blink yellow.
 - When the battery temperature is too low (below 5°C/41°F) or too high (above 40°C/104°F), the charger will stop charging until the temperature is within the acceptable range. The charging process may take longer as a result. During this time, the LED indicator light on the charger will remain solid yellow.
-

Installing & Removing the Battery

Installing the Battery

To install the battery, line up battery hooks with the slots on the top of the Hover Camera Passport and gently slide it in until it locks as shown in the following diagram:

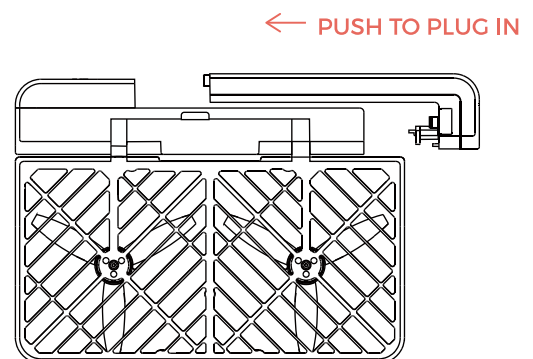

Removing the battery

To remove the battery, pinch the grips at the rear of the battery and gently pull outward as shown in the following diagram:

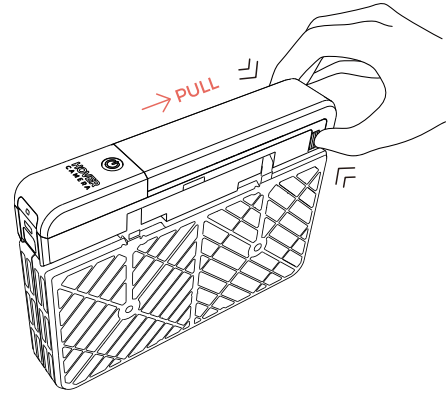

Downloading the Hover Camera App

The Hover Camera app allows you to control Hover Camera Passport through your Android or iOS device.

To download the Hover Camera app, scan the QR code below to get to the Download page with the mobile device you wish to use to control your Hover Camera Passport. You can also visit our official website www.GetHover.com/support to download the app.

The iOS version of the Hover Camera app is compatible with iOS 8.0 or later.

The Android version of the Hover Camera app is compatible with Android 4.4 or later.



Pre-Flight Check

Before each flight session, ensure that:

The mobile device is connected to the Internet and GPS is switched on to ensure that appropriate local Wi-Fi channel is used.

The battery is correctly installed and all other components are functioning properly.

The Hover Camera Passport battery and your connected mobile device are both charged.

The environment and weather conditions are suitable for flight. (See Environment Requirements for Flight section in the following chapter.)

Environment Requirements for Flight

Hover Camera Passport can be operated indoors at suitable venues or outdoors when wind speeds are below 10 km/h (6.2 miles per hour). When wind speeds are 6.2 miles per hour or higher, you may not be able to control Hover Camera Passport properly. This poses a serious risk of damage to the Hover Camera Passport, other property, or injury to nearby persons.

To ensure high quality videos and photos, operate Hover Camera Passport in an environment with minimal or no wind and ensure that there are no obstacles that could disturb photographing or visual flight.

Hover Camera Passport can be flown in temperatures between 5°C - 35°C (41°F - 95°F) and in altitudes no higher than 2000m (6,561ft) above sea level.

Only operate Hover Camera Passport in locations where use is legal.

Operate Hover Camera Passport in a well-lit and spacious environment and do not let it fly beyond visual range.

DO NOT fly Hover Camera Passport in crowded areas to avoid causing injury and make sure that there are no animals in the surrounding area when you are operating Hover Camera Passport.

DO NOT fly Hover Camera Passport in areas or near buildings with no-flying signs.

DO NOT fly Hover Camera Passport in rain, fog, snow, lightning, hail, storm, winds over 6 miles per hour, or any other extreme weather environments.

DO NOT fly Hover Camera Passport in areas with strong magnetic fields.

Hover Camera Passport relies on an optical flow sensor and sonar to gauge its height and position. The following types of environments may negatively affect the performance of Hover Camera Passport:

- Extremely dark or extremely bright
- Flickering or rapidly changing light conditions

Avoid surfaces with one or more of the following characteristics:

- Solid color

- Reflective or transparent
- Moving
- Strong sound absorption
- Irregular or unclear texture
- Repetitive textures
- Inclines greater than 20°
- Snow

Note: For further details, please refer to the Disclaimer and Safety Instructions.

Basic Operation

Status lights

The following chart shows what the various light indicator status' indicate.

Indicator Light	Color and LED Status	Hover Camera Passport Status
Power Button	Solid White	1. Ready to fly 2. Flying
	Blinks White slowly	Self-checking when Hover Camera Passport is turned on
	Blinks White quickly	The firmware is upgrading
LED Indicator Light	Solid Green	Connected to a USB port
	Blinks Green slowly (three times) + blinks green quickly	Gesture Recognition Photos
	Blinks Green Twice	When Hover Camera Passport is turned on
	Solid Yellow	1. Fail to initialize after self-checking. 2. The environment is inappropriate for flying.
	Blinks Yellow	Low Battery
	Blinks Red once	Taking a single photo
	Blinks Red constantly	Recording a video

Powering On/Off

Powering On

To power on Hover Camera Passport, long-press the power button for 2 seconds and the LED indicator light will flash green twice. Hover Camera Passport has an approximately 15-second initialization process, after which the front facing camera will tilt down and then up once to calibrate the camera position, followed by a beep to indicate that the process is complete and that it is in Standby mode.

Note:

When turning on the device, Hover Camera Passport will perform a self-check. The LED indicator light will remain solid yellow if there are any errors. In this case, restart Hover Camera Passport and see if the problem has gone. If the problem still exists, contact with the customer service.

Powering Off

To power off Hover Camera Passport, long-press the power button for 2 seconds while Hover Camera Passport is in Standby mode. The front camera will tilt down and up followed by a beep to indicate the process is complete.

Standby Mode

When Hover Camera Passport is in Standby mode, the power button light turns solid white, indicating that Hover Camera Passport is ready for flight. If Hover Camera Passport is idle for 10 minutes in Standby mode, it will automatically power off.

Pairing Hover Camera Passport to Your Mobile Device

Hover Camera Passport connects to mobile devices directly through Wi-Fi. The connection process is as follows:

1. Power on Hover Camera Passport.
2. Go to your mobile device's Wi-Fi Settings page; Or click on the "Connect Wi-Fi" icon to enter your mobile device's Wi-Fi Settings page.

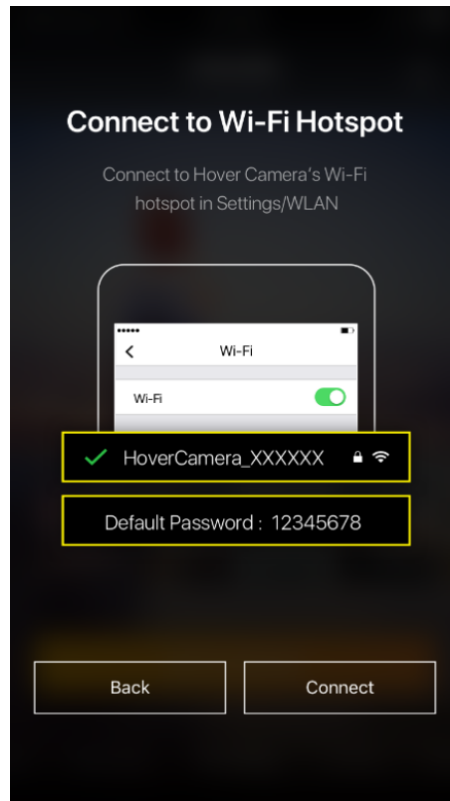

3. Locate and tap on Hover Camera Passport's Wi-Fi name. The name will be in the format HoverCamera_XXXXXX where XXXXXX is a unique 6-digit number specific to your device.
4. When prompted, enter the Wi-Fi password (Default Wi-Fi password: 12345678).

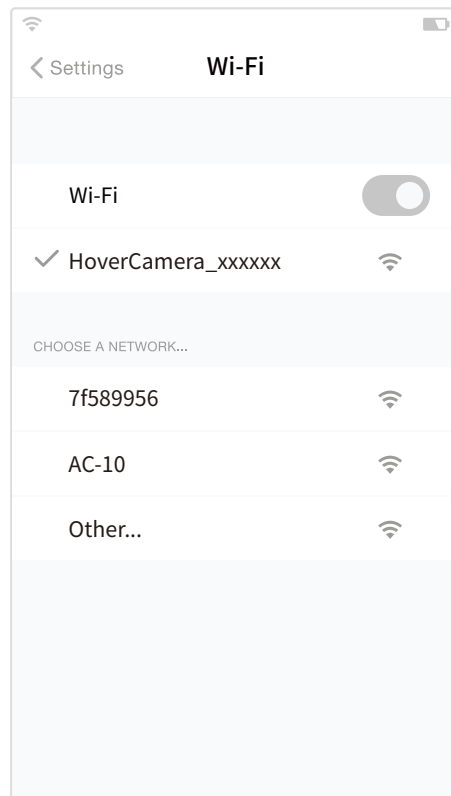

If your mobile device supports 5 GHz Wi-Fi, when the Hover Camera App is launched for the first time, it will prompt you to select the Wi-Fi channel (2.4 GHz or 5 GHz) you prefer to use. This option can be changed in the settings menu.

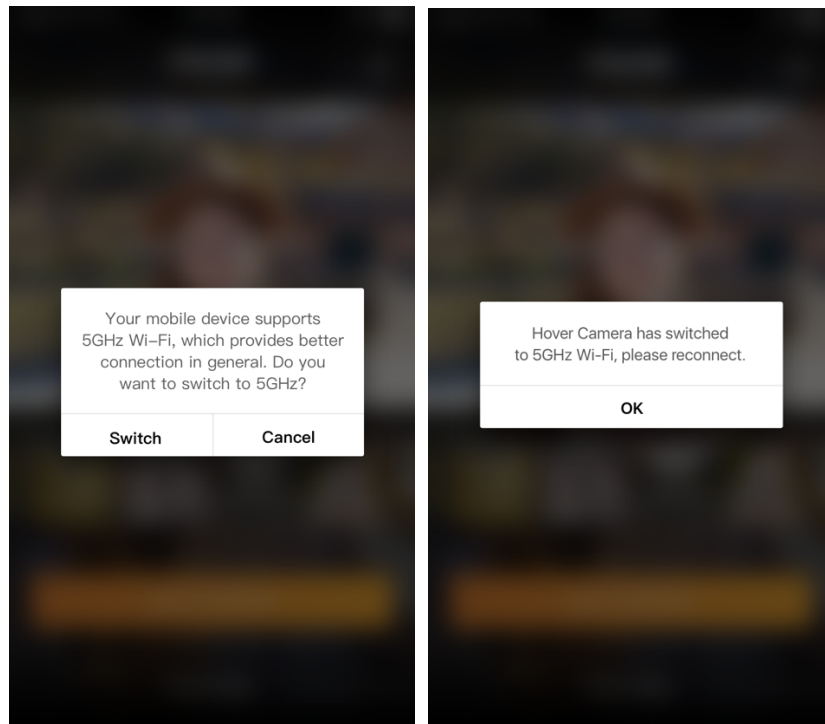

Note:

- 1.Users can change the password, Wi-Fi name, and Wi-Fi channel in “Hover Camera App-Settings-Set Wi-Fi Info” .
 - 2.One or more mobile devices can connect to the Wi-Fi of Hover Camera Passport at a time, but only the user who launches Hover Camera app will have the access to Hover Camera Passport. When the mobile device controlling Hover Camera Passport has exited the Hover Camera app, then it is possible for other mobile devices to get the access.
 - 3.Some countries and regions does not support some Wi-Fi band. Hover Camera will reset the Wi-Fi frequency to conform to the requirements of the Wi-Fi limit of the region that Hover Camera Passport is connected for the first time.
-

Release and Hover

In Standby mode, unfold Hover Camera Passport and press the power button. Once the propellers start spinning, hold Hover Camera Passport horizontally and steady and the system will determine if Hover Camera Passport is ready for flight. If flight conditions are met, the propeller speed will increase and you can release Hover Camera Passport. Hover Camera Passport will hover in place and requires no further actions to keep it airborne.

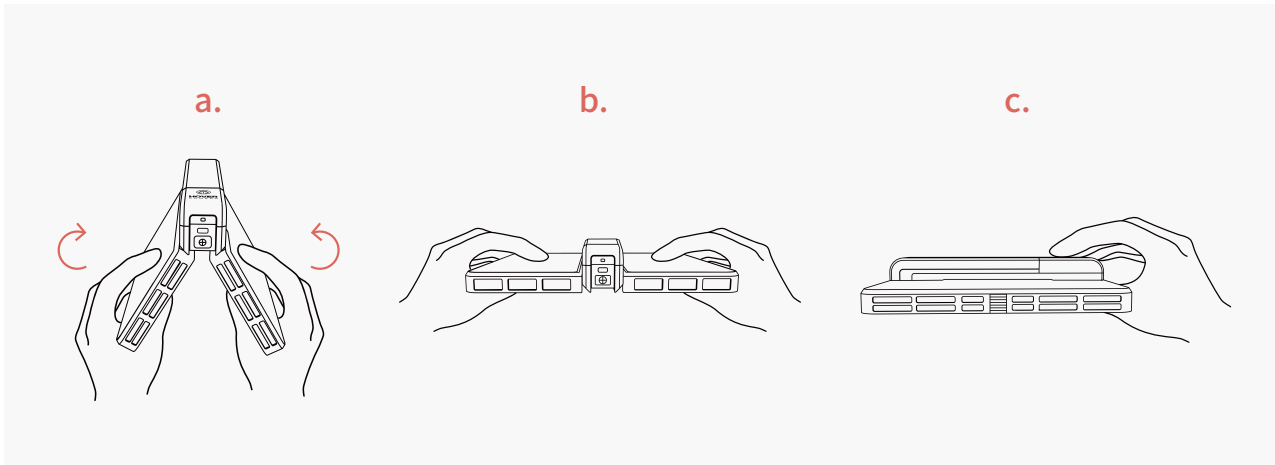

Note:

- Do not cover the Optical Flow Sensor and sonar sensor at the bottom of Hover Camera Passport when releasing Hover Camera Passport.

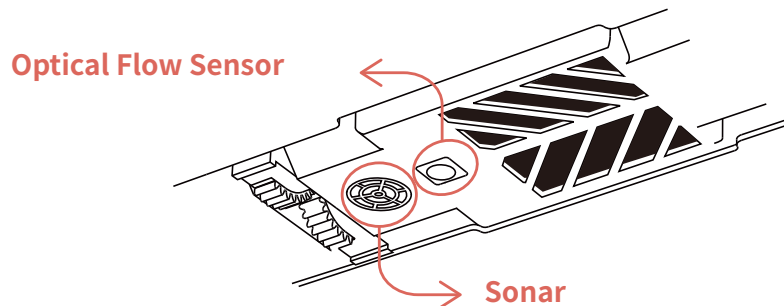



- If the LED indicator light on Hover Camera Passport is solid yellow, the environment is not suitable for flight or the optical flow and sonar sensors have been shielded. Ensure that you are holding Hover Camera Passport with sensors unshielded or relocate to a more suitable environment if the environment is unsuitable.
- Hover Camera Passport must be at least 12 inches from the ground for a proper release.
- Load flight is not allowed for Hover Camera Passport.

Retrieving Hover Camera Passport from Flight

There are two ways to retrieve Hover Camera Passport.

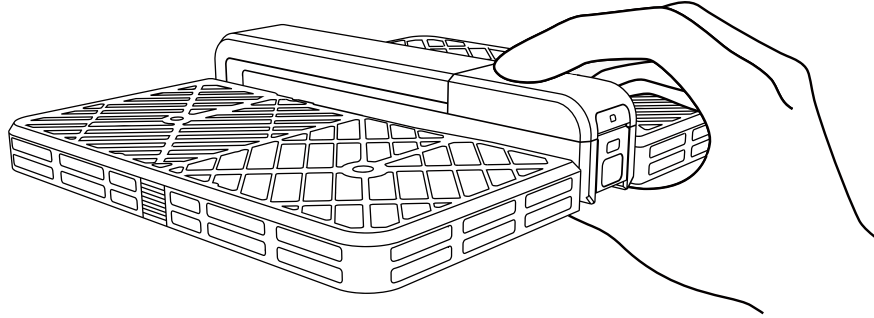
1. Control Hover Camera Passport to the position in front of the user, grab it as illustrated and quick-press the power button to enter Standby mode.



2. Control Hover Camera Passport to the environment that can safely land, and then tap the icon  on the left side in the Hover Camera App. Hover Camera Passport will land slowly.



Note:

Do not insert fingers into carbon fiber case while retrieving Hover Camera Passport.

For more information about safely retrieving Hover Camera Passport, please refer to Disclaimer and Safety Instructions.

Low Battery Level

Battery Level	60s of flight time left	30s of flight time left
LED Indicator Light	Blinks yellow	Blinks yellow
In-App Notification	Landing Soon	Landing
Action	Users should fly Hover Camera Passport to a location suitable for landing.	Hover Camera Passport begins to land automatically. No control is allowed during this process.

Introduction to Functions

Hover Camera app provides 8 kinds of experience modes including Owner Mode, Manual Control, Group Photo, Birds-Eye, Running, Cycling, Orbit and 360 Spin. When users enter the app for the first time, users can only enter the Owner Mode. Other modes will unlock once the user completes the experience in First Step mode. Hover Camera app offers several tutorial videos for each mode. The first time you enter the mode, you must watch the tutorial videos marked with  to enter the app real-time video feed. The user can view the tutorial videos in the real-time video feed, or in the "Hover Camera app – Settings - Tutorial".

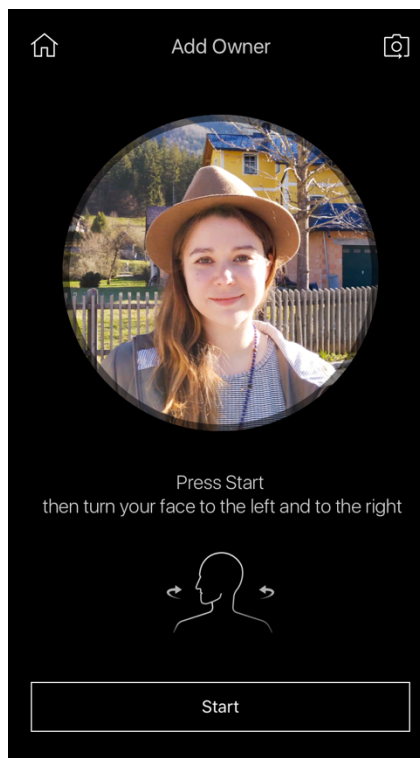
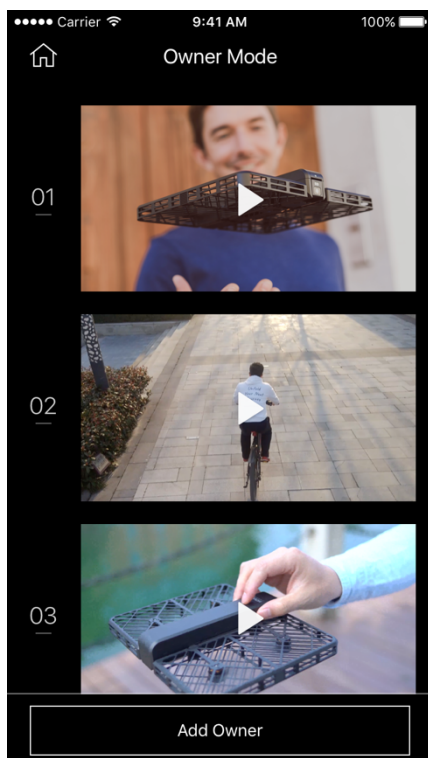

Owner Mode

1. Select Owner Mode, and click the "GET STARTED" button to enter the page of tutorial videos.
2. Click on the " Add Owner" button to add owner. Aim the mobile phone' s lens at your own or others to make the face be in the circle on the screen.
3. Click the "Start" button to start recording the face, and turn the head in order to record facial features. When the face features are recorded and uploaded successfully, you can enter the real-time video feed of Owner mode.

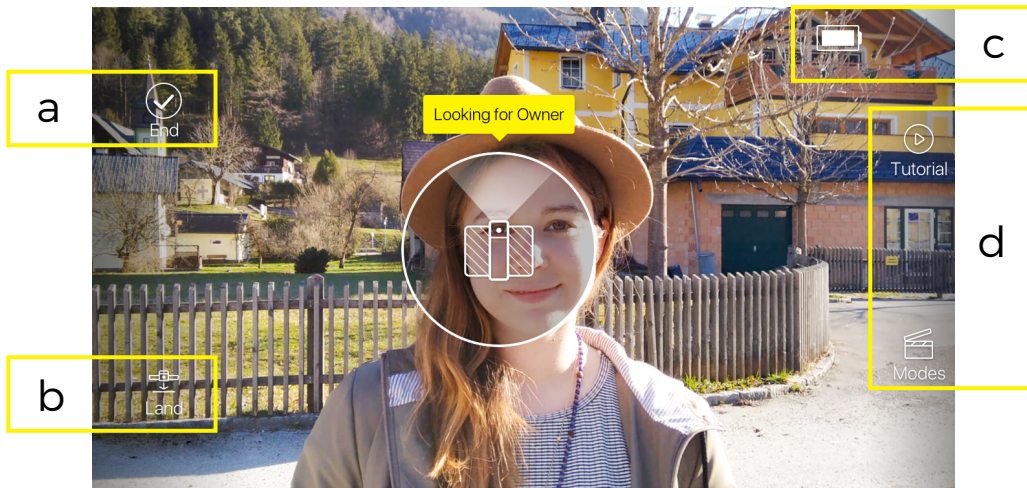

- a. Tap on "End" icon, user will leave the current real-time video feed and go back to the home page.
 - b. Landing
 - c. Battery Level. If the battery level is extremely low, the icon will turn red.
 - d. Users can watch tutorial vides or switch control mode in the sidebar of the real-time video feed.
4. When Hover Camera is released, it will spin 360° to find the owner. During this process, users can control Hover Camera Passport to fly to a position with better perspective.

Manual Control

Control Hover Camera Passport using virtual control pads.

Arrow buttons on the left adjust altitude.

Right control pad adjusts flying direction:

Up/Down arrow makes Hover Camera Passport fly away from/toward the user.

Left/Right arrow makes Hover Camera Passport strafe to the user's left/right.

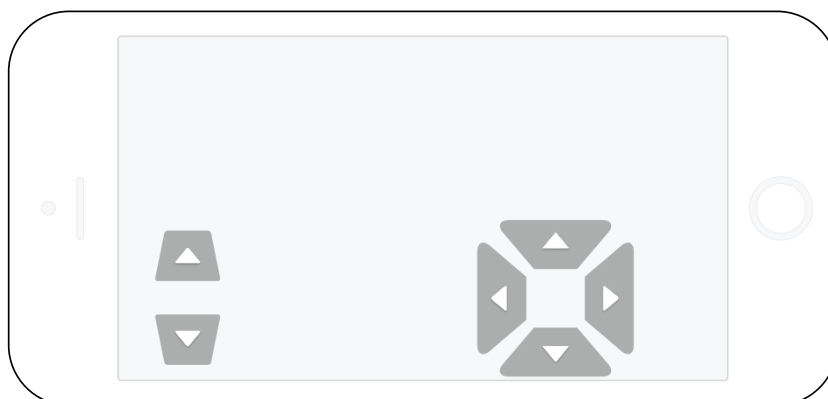

- When the owner is found, Hover Camera Passport will follow and start to take video of him/her. Then the owner will be around by a green selection frame, with the recording time appearing at mid top of the screen and the red dot flashing indicating that the recording is in process.

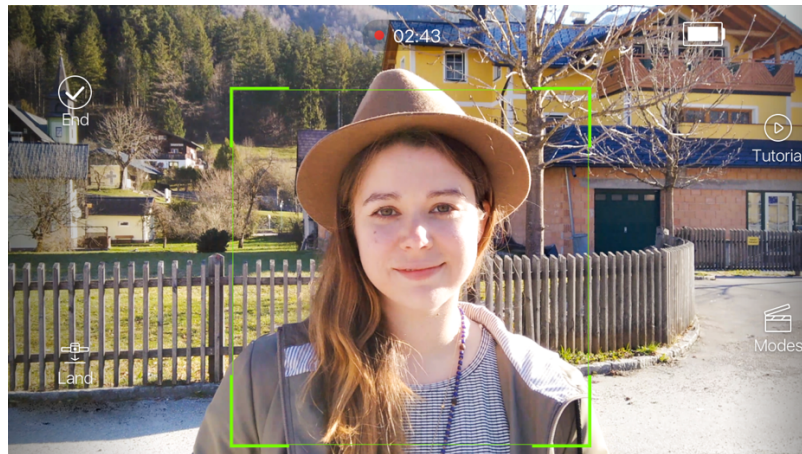

- In First Step mode, users can make the Timer Mode activated using the gesture “👉”.
- Tap on the green frame or use the gesture “👉” to opt out the “Owner mode”, and stop recording.

Users can restart the “Owner Mode” by tapping on the icon. 

- Tap on the “End” icon ☑, users will exit the real-time video feed and the downloading page will appear to remind users of downloading the photos or videos taken just now.
- Users can tap the “change owner” button to record new facial information each time users enter the First Step mode.

Note:





Gesture recognition is only available in Owner mode.

The photo/video downloading page will appear each time users exit any mode of the app.



Manual Control

- Choose Manual Control mode and enter the preview.



2. Video taking mode is activated by default. Tap  to start recording, and tap  to stop recording.
3. Users can tap  to switch to photo taking mode.
4. In photo mode, users can tap  to choose timer mode, flash mode, mirror mode and control mode.

In video mode, users can tap  to choose mirror mode and control mode

Tap  button to enter normal mode. Tap  button to enter timer mode. Normal mode is activated by default.

There are three flash modes including Off, On and Auto.

Mirror view is activated by default, namely the camera of Hover Camera Passport is facing the user.

Please switch to “Facing Me”  when the camera of Hover Camera Passport is facing towards the user.

Please switch to “Facing Away”  when the camera of Hover Camera Passport is facing away the user.

There are three control modes in Manual Control including Classic Mode, Motion Mode and Joystick Mode.

Classic Mode

See control methods in Owner Mode-icons instruction- Manual Controls.

Motion Mode

Use the virtual on-screen slider on the left to control Hover Camera Passport flying up and down.

Tap and hold the button on the right, and tilt your connected mobile device at different angles to control the movement of Hover Camera Passport:

- Tap and hold the button on the right to control flight directions:
 - o Tilting the phone away from/towards you makes Hover Camera Passport fly away from/toward the user.
 - o Tilting the phone left/right makes Hover Camera Passport strafe to the user's left/right.

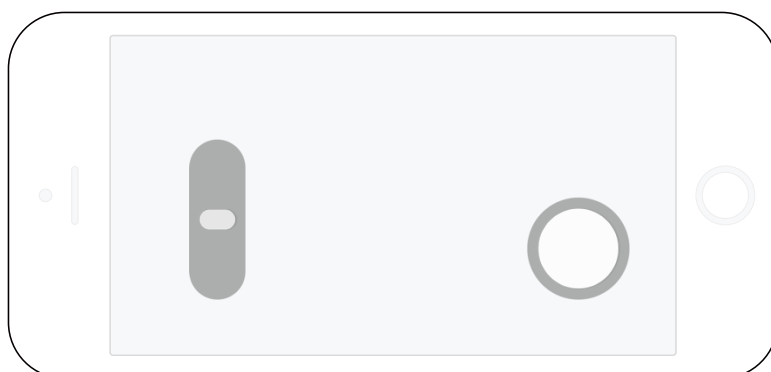

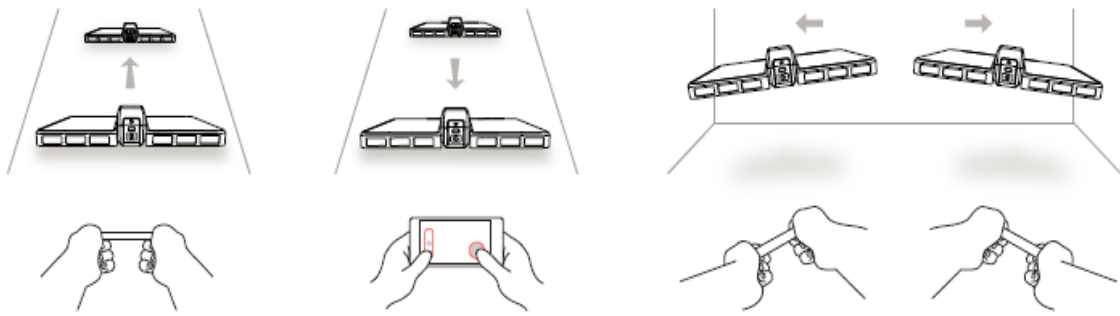

Joystick Mode

- Left joystick controls the altitude and yaw.
- Right joystick controls flight direction:
 - o Pushing joystick up/down makes Hover Camera Passport fly away/toward from the user.
 - o Pushing joystick left/right makes Hover Camera Passport strafe to the user's left/right.

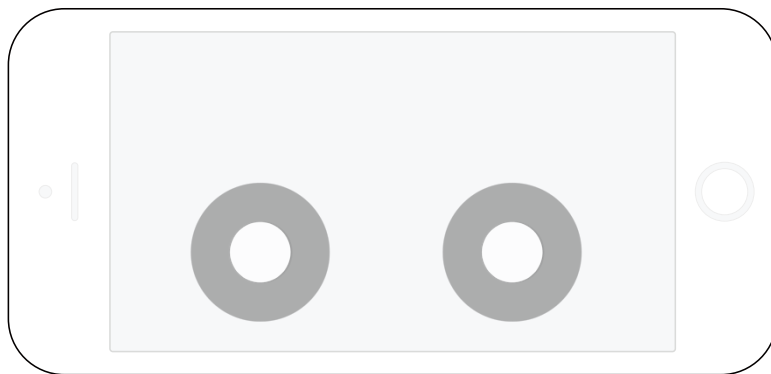

Group Photo & Bird's Eye

1. In Group mode and Birds Eye mode, control Hover Camera Passport to fly to a designate position.

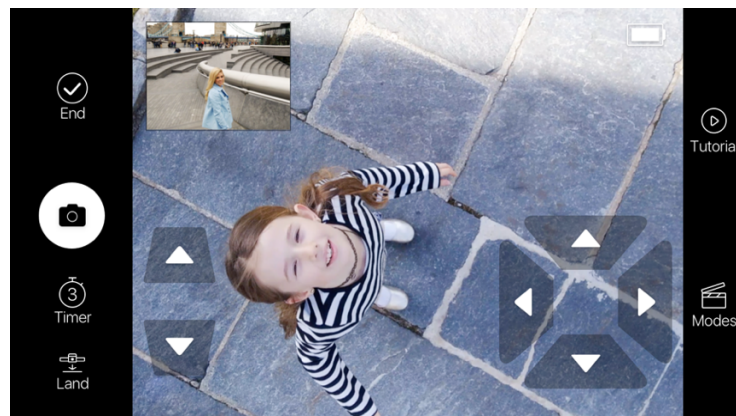

2. Tap the 📷 icon to take a photo. Before taking a photo, users can tap on the timer mode icon ⌚ to switch between normal mode and timer mode.
3. Users can check the thumbnail of photos taken just now shown on the top left corner of the real-time video feed to find out whether they are satisfied with the photos.

Running & Cycling

1. Choose Running mode or cycling mode and enter the real-time video feed.
2. When there is any human body shape appearing in the real-time video feed, there will be yellow frames recognizing the body shapes. Users can tap on one yellow frame to start shooting.
3. The yellow frame will turn to green after the user taps on it, with the REC icon top right corner of the screen flashing indicating that Hover Camera Passport has locked on the selected body and starts auto-record.

Running

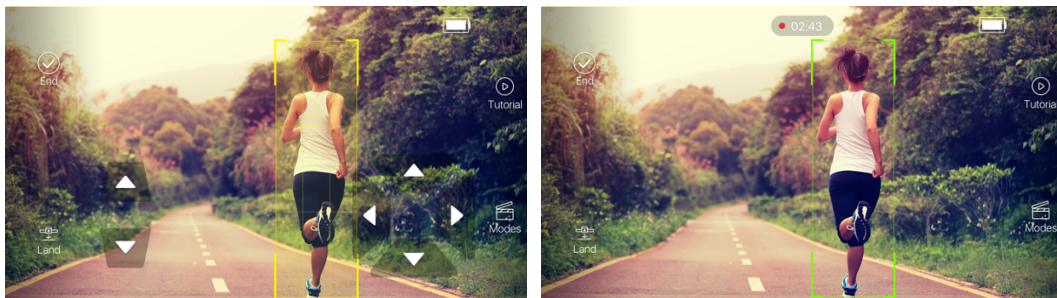

Cycling

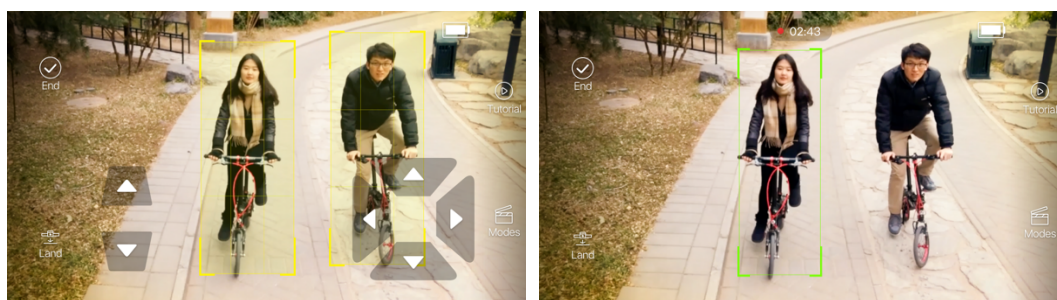



Note:

The speed of Hover Camera in Running mode is around 4m/s .

The speed of Hover Camera in Cycling mode is around 8m/s.



Please avoid braking abruptly in case that Hover Camera Passport may not be able to react instantly.

Orbit

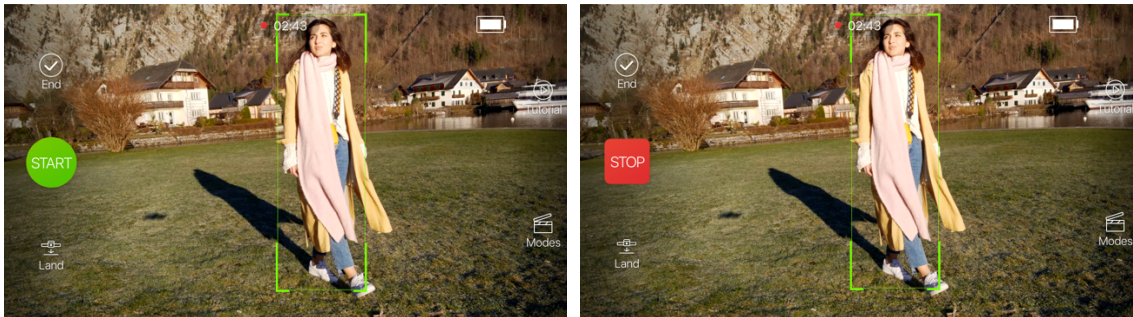
1. Enter the real-time video feed of Orbit mode.
2. Tap on the yellow frames around the bodies in the real-time video feed. The yellow frame will turn green after tapping and Hover Camera Passport will start shooting.
3. Once the user tap , Hover Camera Passport will orbit around the body locked with a fixed radius while recording.
4. Tap  to stop orbiting. Tap on the green frame to stop recording.



360 Spin

1. In 360 Spin mode, once the user taps , Hover Camera Passport pans the camera 360 degrees clockwise around a fixed axis while recording.
2. Tap  to stop spinning and recording.

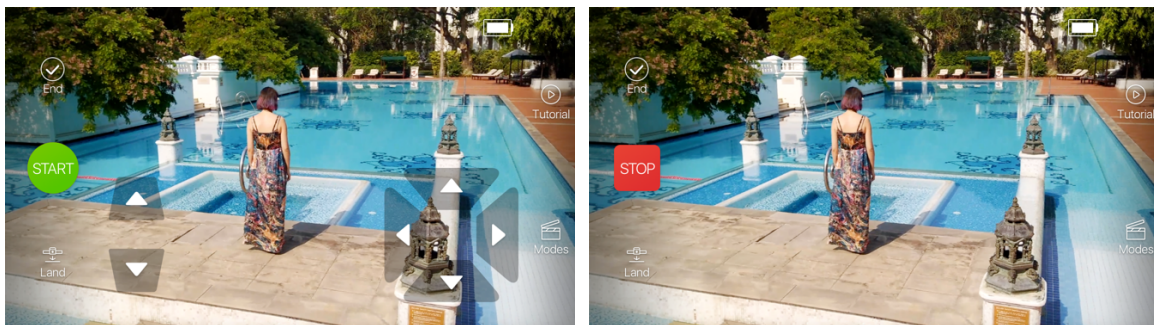

Tilt and Yaw

By sliding your finger upwards or downwards on the real-time video feed of your connected mobile device, you can tilt the camera up or down, respectively. Swiping your finger on the real-time video feed of your connected mobile device to adjust the yaw of Hover Camera Passport.

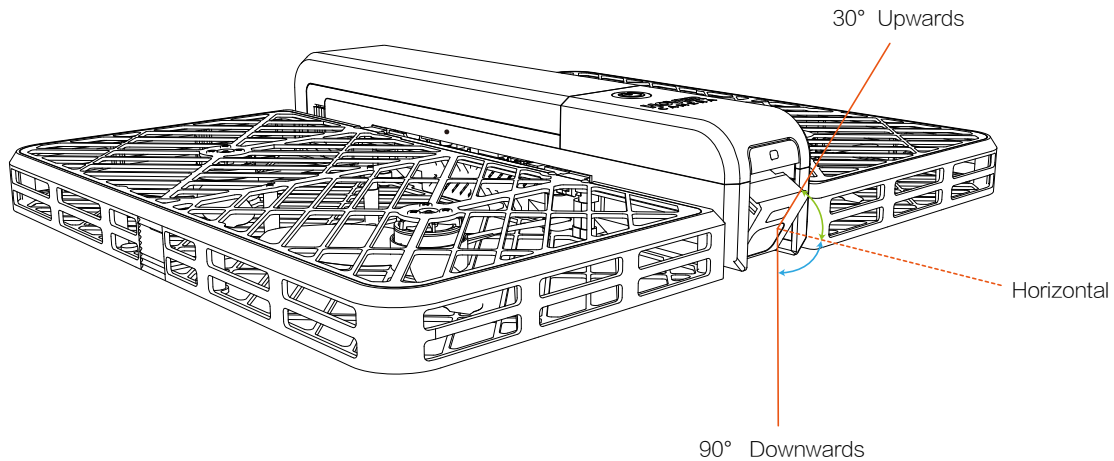

By sliding your finger upwards or downwards on the real-time video feed of your connected mobile device, you can tilt the camera up or down, respectively.

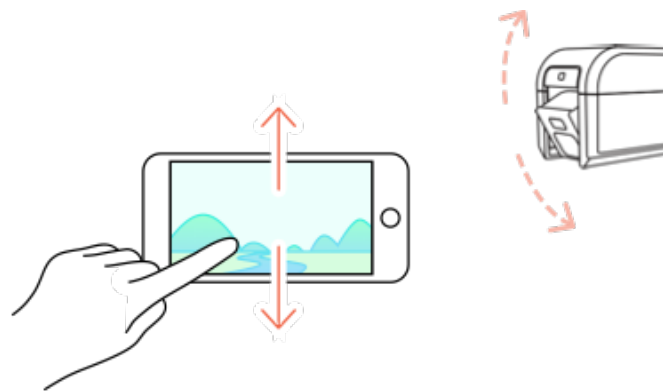

Swiping your finger on the real-time video feed of your connected mobile device to adjust the yaw of Hover Camera Passport.

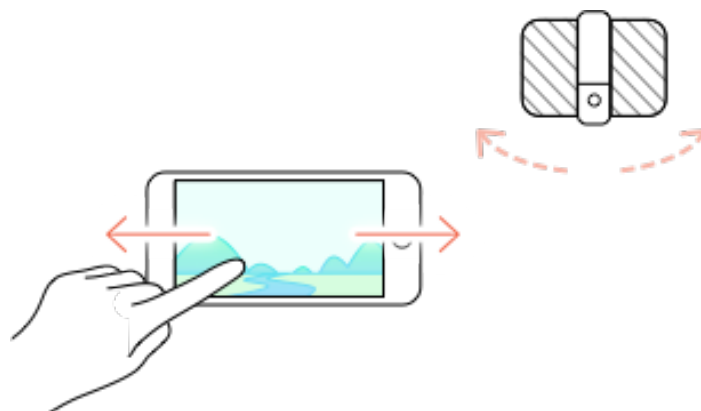

Adjusting Exposure

Setting Automatic Exposure

In photo mode, touching an area of the real-time video feed sets its brightness as the standard exposure for the entire photo. If Hover Camera Passport moves after selecting an exposure area, the auto-exposure area will move back to the center of the real-time video feed.

Setting Automatic Exposure Lock

Long pressing an area of the real-time video feed for 2s locks its brightness as the standard exposure for the entire photo. The yellow frame turns green to indicate that Auto-Exposure Lock (AE-L) mode is enabled and the exposure will not change even if the scene composition changes. Users can manually adjust brightness by moving the slider on the bar at the top of the screen. Tap the screen again to disable AE-Lock.



Social Hub

Users can view Social Hub in each mode. The photos and videos in each Social Hub are selected from all the content submitted by users.

Album

Downloading & Management

When users exiting any mode back to the home page, a downloading page will appear to remind them of downloading the photos and videos taken. Sessions will be displayed after the Social Hub in a sequential

order, and more recent sessions come first. Users can also go to “Hover Camera app – Settings – Memory Management” to download the photos and videos they want.

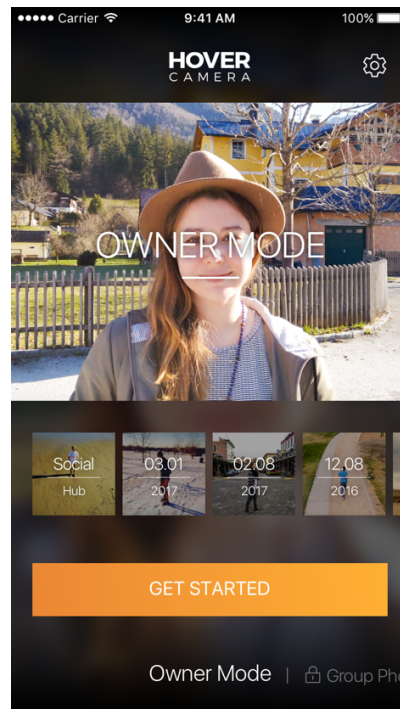

Note:

Users need to connect to Hover Camera Passport’s Wi-Fi to download photos and videos.

Transferring Files from Hover Camera Passport to Your Computer

Hover Camera Passport needs to be in Standby mode to transfer files to a computer through a USB cable.

Once Hover Camera Passport is connected, the auto play window will pop up automatically. Choose "Open Folder to view files" and then you can choose which files you would like to save to the computer.

iOS supports the wireless transfer of 720p & 1080p videos from Hover Camera Passport. 4K videos need to be downloaded to your computer through a USB cable. There is no limit for Android users.

Note:





Hover Camera Passport must be powered on and successfully paired to transfer photos and videos wirelessly to your connected mobile device.

Editing and Sharing

Choose one photo from album to edit.

Video editing and sharing

Choose one video from album to edit.

- Tap the  icon to share the video to social media platforms;
- Tap the  icon to get to the video editing page;
- Tap the  icon to delete the video;
- Tap the  icon to return to the previous operation.

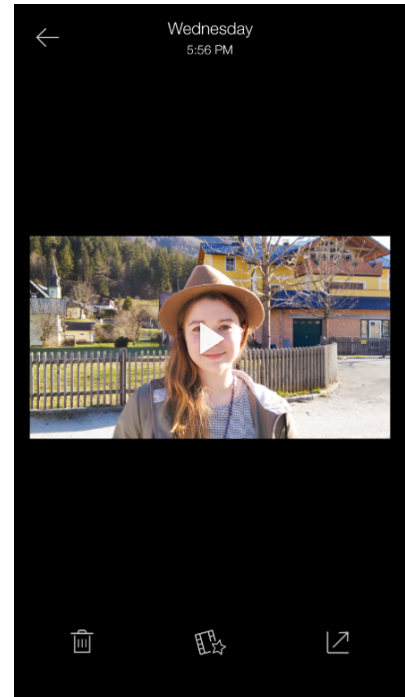



Video clip

In the video editing page, drag the white label on both sides of the video stream to clip the video to the expected position.



Note: The minimum length of the clipped video is 1 second.

Video synthesis



Tap the  icon, and then select the videos you want to synthesize. Then tap the  icon to get to the multiple videos synthesis page.

- Long press and drag the video file to the left/right side to change the order of the video segment;
- Long press and drag the video file to the  icon to delete the video segment;
- Tap the video file to enter the video clip page.

Note: The maximum length of the synthesized video is 60 seconds.

Music Adding

Tap the  icon after clip/ synthesize the video to get to the music adding page.

- Tap the  icon to set the video mute;
- Tap the  icon to add music from iTunes for the video.
- Tap the  icon to randomly select one of the nine kinds of music offered by the APP.
- Tap the music icon, to select one of the nine kinds of music offered by the APP.

Saving and sharing

Tap the  icon after adding music, and the new video will be stored in the album in the phone and get to the sharing page.

Note: Editing the video when Hover Camera is flying is not recommended;
You can edit the video without connecting your phone with the Hover Camera;
You should make your phone connected with a network to share a video.

Settings

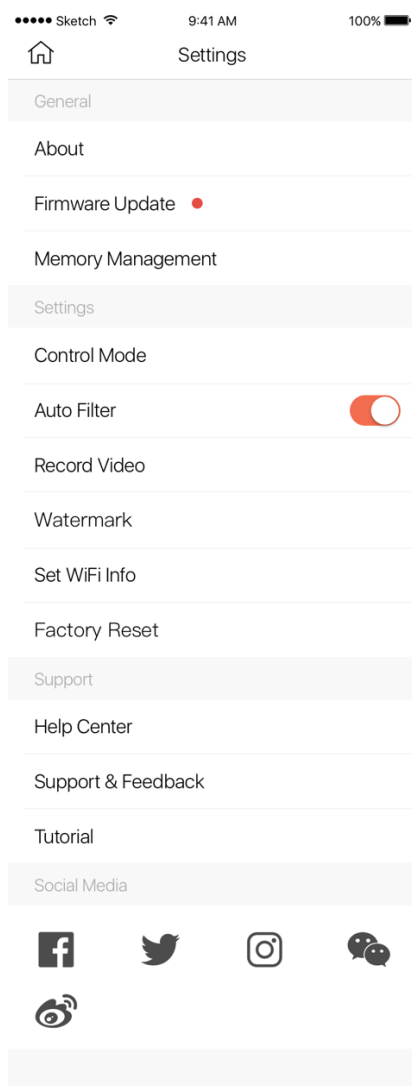

General

About

Displays the current version of the Hover Camera app, Hover Camera Passport's firmware and the terms of service.

Firmware Update

Checks and updates Hover Camera Passport's firmware. For more information see Maintenance and Care – Updating Hover Camera Passport Firmware.

Memory Management

Displays the available storage space remaining and allows users to manage photos and videos. Tap the “Select” button on the upper right corner to delete or transfer multiple photos and videos onto the connected mobile device.

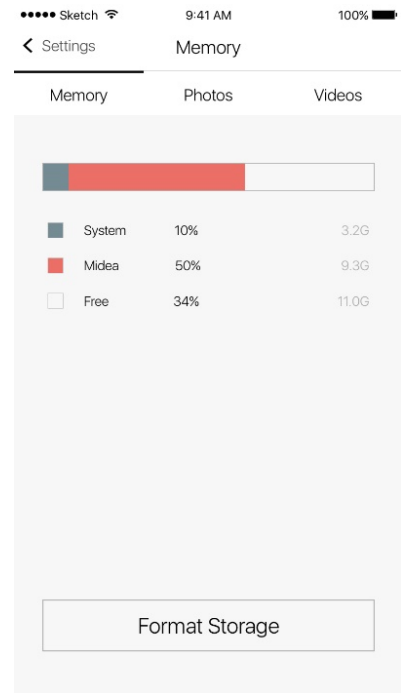

Settings

Control Mode

There are three kinds of control modes including Classic Mode, Motion Mode and Joystick Mode.

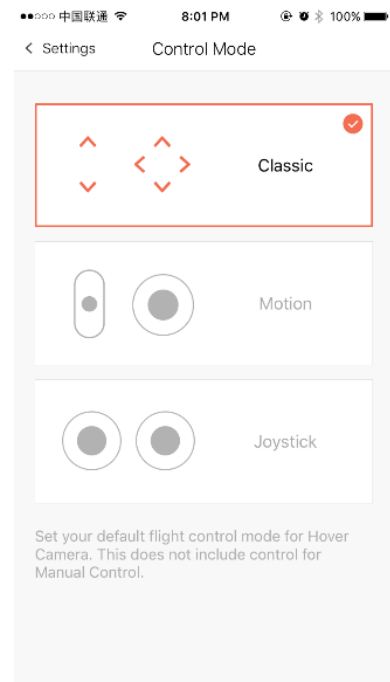

Auto Filter

Add filters to photos and videos.

Owner Mode

Hover Camera will automatically seek for and follow the user when Owner Mode is selected.

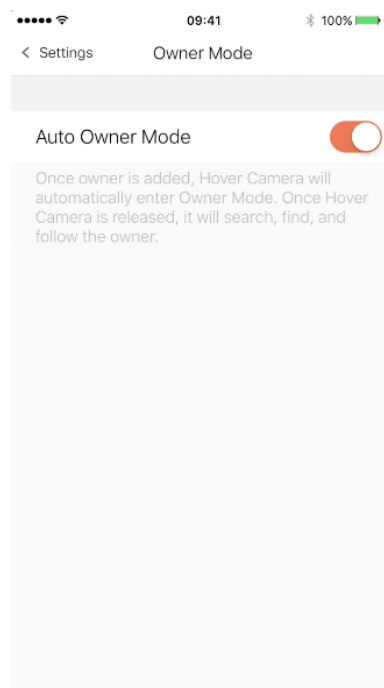

Record Video

Users can choose the resolution of the video from 720p, 1080p and 4K. The resolution is 1080p by default.

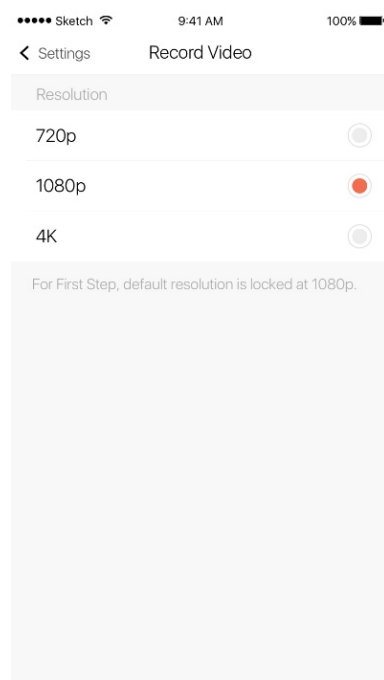

Note: Owner mode and other auto-follow modes only support 1080p.

Watermark

Add watermarks “Hover Camera” for photos and videos.

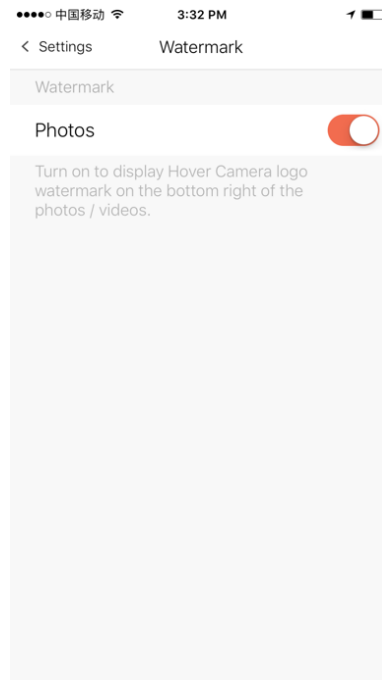

Set WiFi Info

Change Hover Camera Passport's Wi-Fi name and password as well as the Wi-Fi channel (2.4G/5G).

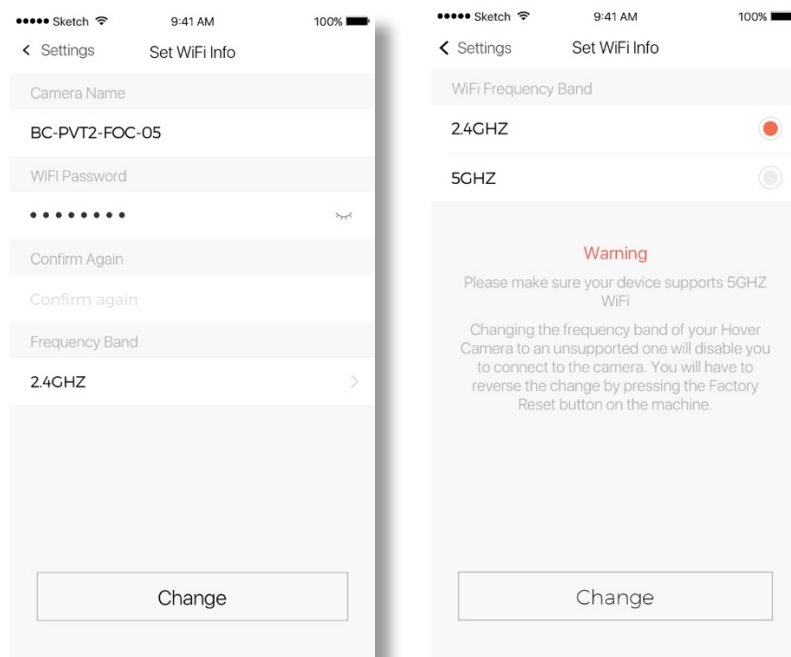

Factory Reset

Reset Hover Camera Passport to factory settings.

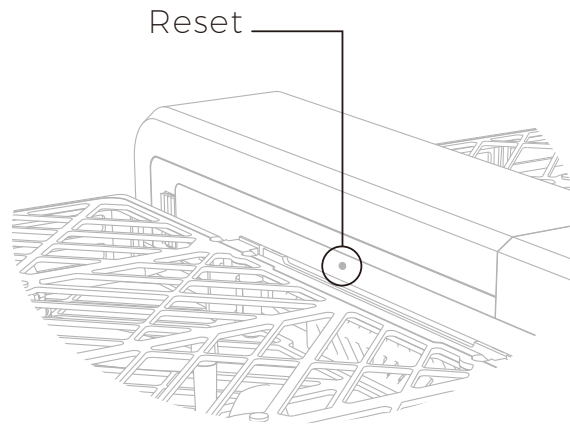

Note:

When power button is solid, you can manually reset Hover Camera Passport by inserting a pin (you can use a paper clip or needle) and pressing down into the reset keyhole.

If Hover Camera Passport cannot start up normally, you can reset it by inserting a pin and pressing down into the reset keyhole for 2 seconds while long pressing the power button at the same time.

The reset keyhole is on the left side of Hover Camera Passport's main body when the camera is facing you.

Support

Help Center

Users will be guided to the support page on the official website.

Send Feedback

Send questions or feedback about Hover Camera Passport to Shenzhen Zero Zero Infinity Technology Co., Ltd. (“Shenzhen Zero Zero”).

Send Hover Camera flight log to Zero Zero by tapping on “Send Log” .

Tutorial

Users can view the tutorial again here.

Social Networking

Users can connect with Shenzhen Zero Zero through social media platforms, such as Facebook, Instagram, WeChat, and Weibo

Maintenance & Care

Users can replace the carbon fiber plate on the bottom of Hover Camera Passport and Hover Camera Passport propellers. Follow the guidelines carefully to replace old or damaged parts, and only use tools and materials provided by Shenzhen Zero Zero.

Replacing the Bottom Carbon Fiber Plate

To remove the bottom carbon fiber plate, remove the screws one by one (no sequence when unscrewing the screws).

To screw on the new plate, first screw in the two edge screws closest to the center, then screw in the two middle screws. The remaining screws can be screwed in any order.

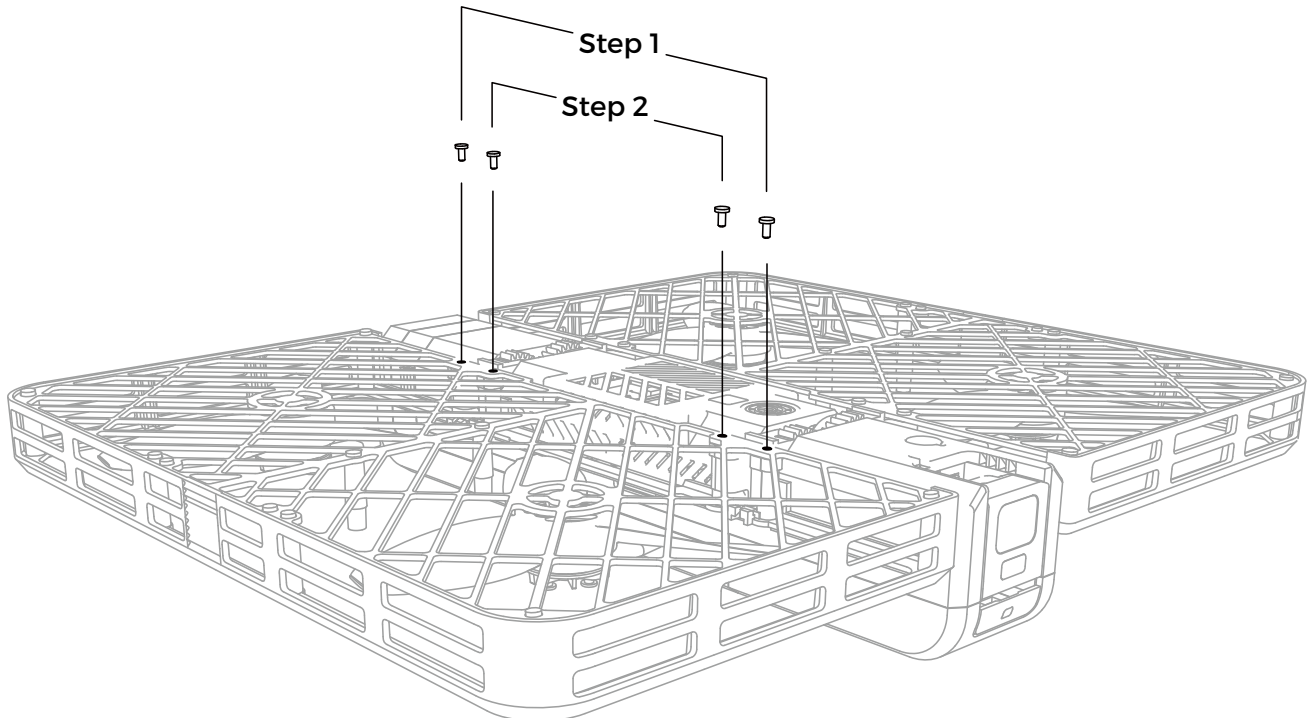

Note:

-
- Carefully unscrew the screws to avoid damaging the threading.
-

Replacing Propellers

Hover Camera Passport has four propellers comprised of two sets (CW and CCW) that rotate in opposite directions. Each set is diagonal from each other. Place propellers onto the corresponding rotors. Propellers do not fit on non-corresponding rotors by design. DO NOT attempt to force the propeller onto the rotor.

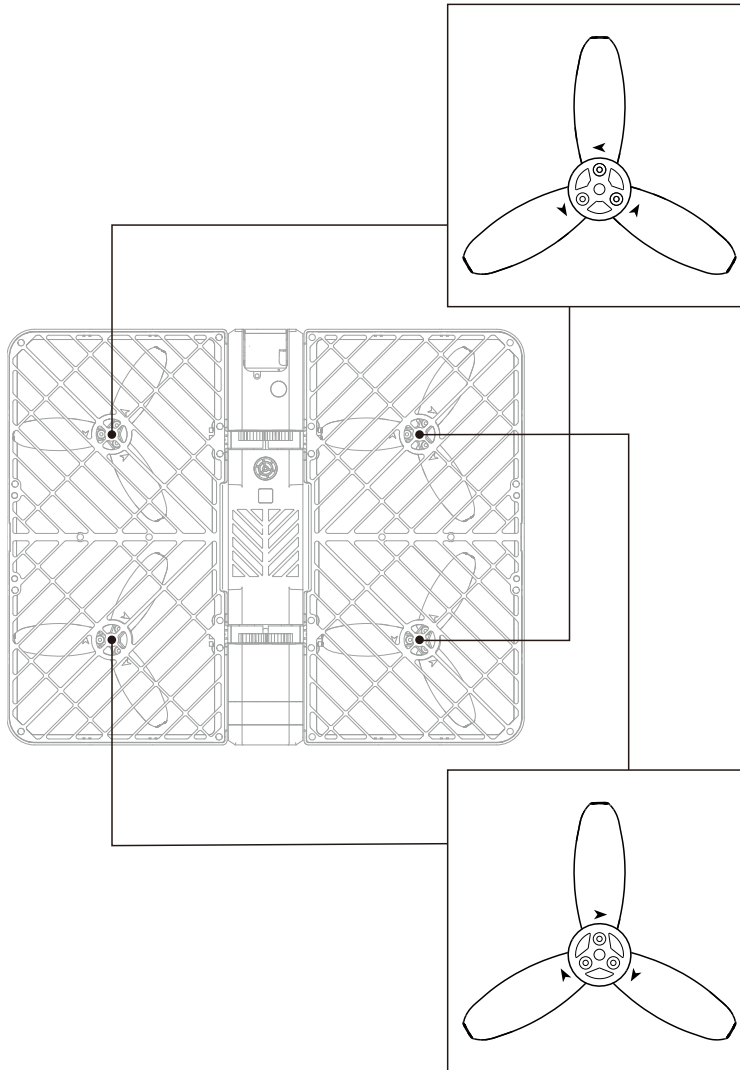

To replace the propellers:

1. Turn over Hover Camera Passport such that the carbon fiber plate is on top.
2. Remove the screws around the carbon fiber plate and remove it.
3. Unscrew the old propellers and remove them by pinching and pulling on the propeller hub (the part conjoined with the rotor).
4. Attach the new propellers by pressing down on the propeller hub onto place and screwing it in. Only CW propellers will fit onto CW rotors and only CCW propellers will fit into CCW rotors. CW and CCW propellers can be identified by the arrows on the propellers. Arrows on CW propellers face right and arrows on CCW propellers face left.

- Screw the carbon fiber plate back on (refer to the above section Replacing the Bottom Carbon Fiber Plate for details).

Note:

- Carefully unscrew the screws to avoid damaging the threading.
 - Do not press on the propeller blades when removing the screws or they may be damaged. Handle the propellers gently when removing or placing them.
 - Do not tighten the propeller screws too loosely or too tightly.
 - There are two types of screws. The screws for bottom plate are longer, while the ones for propellers are shorter. Each propeller requires three (3) screws and each carbon fiber plate requires twelve (12) screws.
 - There are two screwdrivers included with Hover Camera Passport. The grey screwdriver is for shorter screws and the black screwdriver is for longer screws.
-

Battery Disposal

Batteries will become worn, damaged, or otherwise unusable over time. If you encounter one of the follow situations, dispose of the battery according to your local laws and regulations.

- Swollen: battery is visibly swollen, distorted, or deformed.
- Worn: no obvious physical damage, but you experience a dramatic decrease in flying time.
- Damaged: visible damage such as cracks, abrasions, or punctures on the battery.

To avoid damaging your batteries, keep them away from any wet or dusty environments. While they are not in use, detach batteries from Hover Camera Passport and store them in an environment between 14 °F- 104°F. Check Battery Safety Instructions for more information.

Storage & Transportation

Store Hover Camera Passport in the case provided and **DO NOT** place heavy objects on top of it.

Battery storage

Detach the battery and keep it in a proper environment as detailed in the Battery Safety Instructions to avoid over-discharge.

Proper temperature ranges for battery storage:	
Short term (<1 month)	-10°C - 40°C (14°F-104°F)
Long term (>1 month)	-10°C - 30°C (14°F- 86°F)

Transportation

The suitable temperature range for transporting the batteries of Hover Camera Passport is between 18°C - 28°C (64.4°F - 82.4°F).

For more information about Lithium Polymer batteries, please refer to Battery Safety Instructions.

Updating Hover Camera Passport Firmware

Hover Camera Passport's firmware can be updated in two ways:

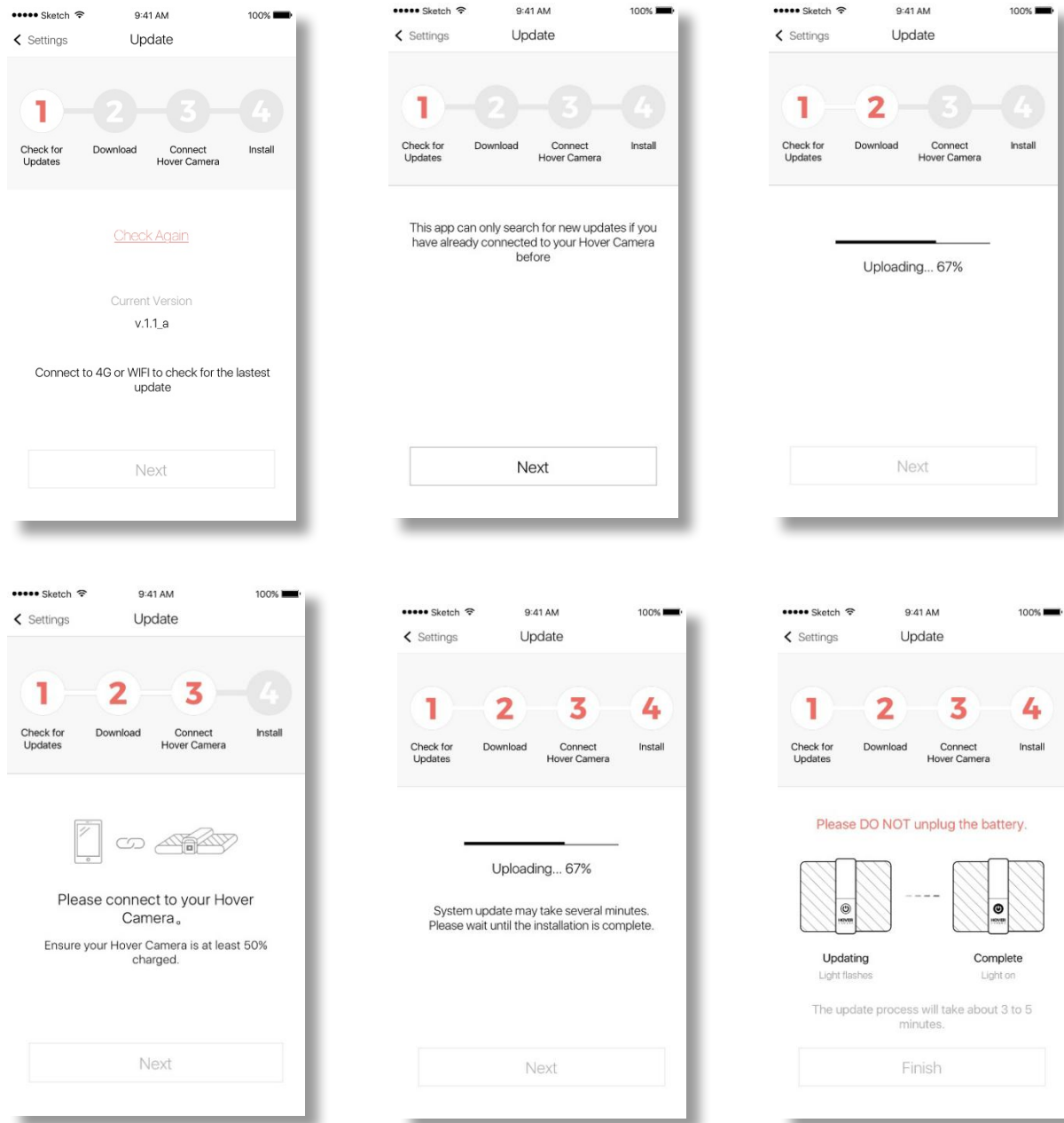

Update from Hover Camera app.

- Obtain Hover Camera Passport's firmware version by connecting the mobile device to Hover Camera Passport.
- Connect your mobile device to the Internet through Wi-Fi to get the updated firmware version. If the firmware version of your Hover Camera Passport is the same as the updated one, then Hover Camera app will inform you that your firmware is the latest version. Otherwise there will be a “download” button. Tap this button to begin downloading the latest firmware.

- c. After the download is complete, Hover Camera app will notify you to connect your mobile device back to your Hover Camera Passport to upload the firmware patch.
 - d. After the upload is complete, Hover Camera Passport starts updating its firmware. The power light will blink quickly during this process. This process will last for about 5 minutes.
 - e. When Hover Camera Passport finishes updating its firmware, the power light will stop blinking and become solid white.
 - f. Please reconnect to Hover Camera Passport's Wi-Fi after updating firmware successfully.
2. Update from USB
- a. Download the updated firmware patch from the official website.
 - b. Connect your Hover Camera Passport to your laptop with the USB cable.
 - c. Copy the downloaded patch to the root directory of Hover Camera Passport's storage.
 - d. Power off Hover Camera Passport and then power it on again.
 - e. The firmware updating process will begin automatically. If it does not, ensure that the patch has been put into the right folder. This process will last for about 5 minutes.
 - f. When Hover Camera Passport finishes updating its firmware, the power light will stop blinking and become solid white.
 - g. Please reconnect to Hover Camera Passport's Wi-Fi after updating firmware successfully.

Note:

-
- When updating the firmware, ensure that the battery of Hover Camera Passport is charged to at least 50%.
 - Once the firmware update completes, you can check whether the update was successful by checking the version number of the updated firmware. To do this, navigate to “Settings -About” .
-

Appendix

Specifications

Hover Camera Passport

Weight: 242 grams (including battery)
Dimensions: 182*132*33mm / 7.2*5.2*1.28 inches
Max Speed: 8m/s (17.9mph)
Max Flight Altitude: 2000m (6561ft)
Max Hovering Time: 10 minutes (No wind)
Suggested Control Distance: Up to 20m (65ft)
Operating Temperature: 5°C(41°F) - 35°C(95°F)
Wi-Fi Frequency Channel: 2.4GHz; 5GHz

Camera

Sensor: 1/3.06" (CMOS); Effective pixels: 13M
Lens: FOV 78.4°; 28mm (35mm format equivalent); f/2.0; Depth of focus: 1.2 - 6.7m
ISO Range: 100 - 3200
Pitch Range: -90° to +30°
Image Max Size: 4208×3120
Video Recording Modes: 4K: 3840×2160 @30fps
1080P: 1920×1080 @30fps
720P: 1280×720 @30fps
Photo/Video Format: JPEG/MP4
Storage: 32GB (including system files)

Battery

Volume: 1360mAh
Voltage: 7.6V
Energy: 10.34Wh
Battery Type: LiPo 2S
Weight: 71g
Operating Temperature: 5°C(41°F)-40°C(104°F)

Charger

Voltage: 11-20V
Rated Power: 36W

After-Sales Information

For information regarding after-sales services and warranty information, please visit the following pages:

1. Warranty: <http://www.GetHover.com/support/warranty>
2. Refund and Exchange Policy: <http://www.GetHover.com/support/refund-and-exchange>
3. Return Merchandize Authorization: <http://www.GetHover.com/support/rma>

Compliance Information

FCC Compliance Statement

This device complies with part 15 of the FCC Rules. Operation is subject to the following two conditions: (1) This device may not cause harmful interference, and (2) this device must accept any interference received, including interference that may cause undesired operation.

Shielded cables must be used with this unit to ensure compliance with the Class B FCC limits.

Note: This equipment has been tested and found to comply with the limits for a Class B digital device, pursuant to Part 15 of the FCC Rules. These limits are designed to provide reasonable protection against harmful interference in a residential installation. This equipment generates, uses and can radiate radio frequency energy and, if not installed and used in accordance with the instructions, may cause harmful interference to radio communications. However, there is no guarantee that interference will not occur in a particular installation. If this equipment does cause harmful interference to radio or television reception, which can be determined by turning the equipment off and on, the user is encouraged to try to correct the interference by one or more of the following measures:

Reorient or relocate the receiving antenna.

Increase the separation between the equipment and receiver.

Connect the equipment into an outlet on a circuit different from that to which the receiver is connected.

Consult the dealer or an experienced radio/television technician for help.

FCC Radiation Exposure Statement

This transmitter must not be co-location or operating in conjunction with any other antenna or transmitter.

This equipment complies with FCC RF radiation exposure limits set forth for an uncontrolled environment.

This equipment should be installed and operated with a minimum distance of 7.9 inches between the radiator and your body.

IC RSS Warning

This device complies with Industry Canada license-exempt RSS standard (s). Operation is subject to the following two conditions: (1) this device may not cause interference, and (2) this device must accept any interference, including interference that may cause undesired operation of the device.

IC Radiation Exposure Statement

This equipment complies with IC RF radiation exposure limits set forth for an uncontrolled environment.

This transmitter must not be co-located or operating in conjunction with any other antenna or transmitter.

This equipment should be installed and operated with minimum distance 7.9 inches between the radiator & your body. Any Changes or modifications not expressly approved by the party responsible for compliance could void the user' s authority to operate the equipment.

Canadian IC Warning

This device complies with Industry Canada license-exempt RSS standard(s). Operation is subject to the following two conditions: (1) this device may not cause interference, and (2) this device must accept any interference, including interference that may cause undesired operation of the device. Le présent appareil est conforme aux CNR d'Industrie Canada applicables aux appareils radio exempts de licence. L'exploitation est autorisée aux deux conditions suivantes : (1) l'appareil ne doit pas produire de brouillage, et (2) l'utilisateur de l'appareil doit accepter tout brouillage radioélectrique subi, même si le brouillage est susceptible d'en compromettre le fonctionnement. The device is compliance with RF eld strength limits, users can obtain Canadian information on RF exposure and compliance. Le présent appareil est conforme de ce matériel aux conformités ou aux limites d'intensité de champ RF, les utilisateurs peuvent sur l'exposition aux radiofréquences et la conformité and compliance d'acquérir les informations correspondante. This Class B digital apparatus complies with Canadian ICES-003. Cet appareil numérique de la classe B est conforme à la norme NMB-003 du Canada.

The device is going to be operated in 5150~5250MHz frequency range.

It is restricted indoor environment only.

EU Compliance Statement

Hereby, Shenzhen Zero Zero Infinity Technology Co., Ltd. declares that this device is in compliance with the essential requirements and other relevant provisions of Directive 1999/5/EC. The declaration of conformity may be consulted at

www.gethover.com/euro-compliance/Hover-Camera-Passport.

RoHS Compliance Statement

We hereby confirm with legal force that all the products we supply to you comply with the requirements of RoHS directive 2011/65/EU, status as at June 8th, 2011.

The substances and preparations used come under the following exemptions quoted in Annex V and/or Annex VI of RoHS.

We are currently examining our products and will let you know result no later than.

We can not replace these substances at present for technical (or other) reasons.

WEEE Compliance Statement



Correct Disposal of this product. This marking indicates that this product should not be disposed with other household wastes throughout the EU.

To prevent possible harm to the environment or human health from uncontrolled waste disposal, recycle it responsibly to promote the sustainable reuse of material resources.

To return your used device, please use the return and collection systems or contact the retailer where the product was purchased. They can take this product for environmental safe recycling.



Operating Temperature: 5°C- 40°C

CAUTION:

Risk of explosion if battery is replaced by an incorrect type. Dispose of used batteries according to the instructions.

(1) 이 기기는 가정용으로 전자파적합등록을 한 기기로서 주거지역에서는 물론 모든 지역에서 사용할 수 있습니다.

(2) 당해 무선설비는 전파혼신 가능성이 있으므로 인명안전과 관련된 서비스는 할 수 없음.

根據NCC低功率電波輻射性電機管理辦法 規定:

(1)第十二條經型式認證合格之低功率射頻電機，非經許可，公司、商號或使用者均不得擅自變更頻率、加大功率或變更原設計之特性及功能。

(2)第十四條

低功率射頻電機之使用不得影響飛航安全及干擾合法通信；經發現有干擾現象時，應立即停用，並改善至無干擾時方得繼續使用。

前項合法通信，指依電信法規定作業之無線電通信。

低功率射頻電機須忍受合法通信或工業、科學及醫療用電波輻射性電機設備之干擾。